

BOURDON TUBE PRESSURE GAUGES

Type: 6004

Case diameter: 50 MM

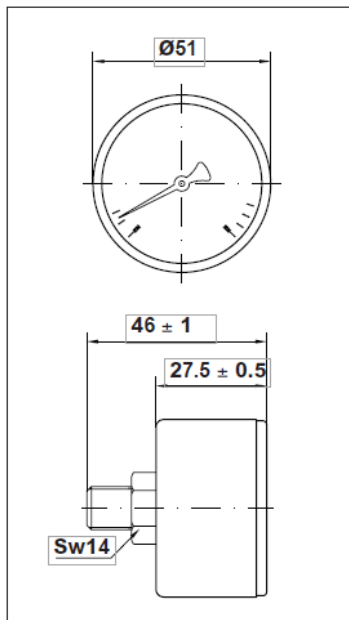
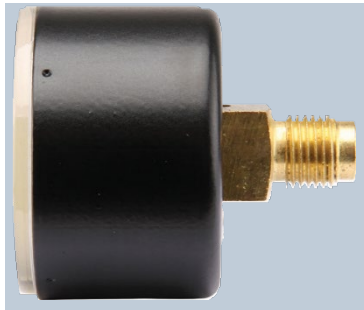

Dry Steel Case DN50 Back Entry

Materials

Case:	Black steel, powder coated
Window:	Clear plastic
Dial:	White aluminium
Pointer:	Black aluminium
Pressure connection:	Cu-alloy, G 1/4", 14 mm flats
Pressure element:	Bourdon tube Cu-alloy soft soldered, < 60 bar C-type, >60 bar helical type
Movement:	Cu-alloy

Technical Specifications

Design:	EN 837-1
Working pressure:	Steady: 75 % of full scale value Fluctuating: 60 % of full scale value Short time: full scale value Over pressure limit: 120 % of max scale value
Operating temperature:	Ambient: -20 ... +60 °C Medium: +60 °C maximum
Storage:	-20 ... +60 °C
Temperature effect:	Deviation from reference temperature (+20°C) ±0,04%/1K of the span
Accuracy class:	cl. 2.5 to the full scale value
Degree of protection:	IP 31 per EN 60 529 / IEC 529
Individual Weight:	0.088 kg
Range:	-1 + 0 to 0-400 Bar